

GT4-OSL lenses for Osram's Oslon SSL series of LEDs



- Specially designed for Osram's Oslon SSL series of LEDs.
- Special care taken to make a uniform white or warm white illumination. Lenses work well with other colors, too.
- Lens material optical grade PMMA. Allows use of high current and temperature conditions
- Best available optical efficiency, up to 90%.

LENS TYPES

NAME	ORDERING CODE	FWHM
GT4-OSL Smooth Spot	C10921_GT4-OSL-S	±10°
GT4-OSL Medium	C10922_GT4-OSL-M	±14°
GT4-OSL Wide	C10923_GT4-OSL-W	±16°
GT4-OSL WW	C10975_GT4-OSL-WW	±22°

© Ledil Oy – PRELIMINARY - Subject to change without prior notice

MEASUREMENT DATA

Relative Intensity of C10921_GT4-OSL-S

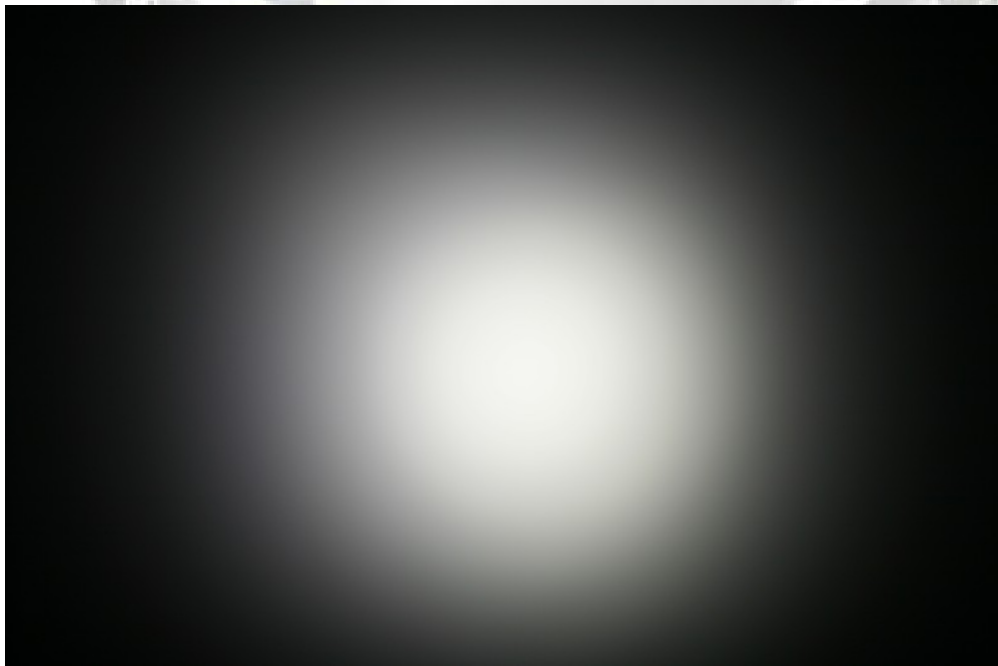
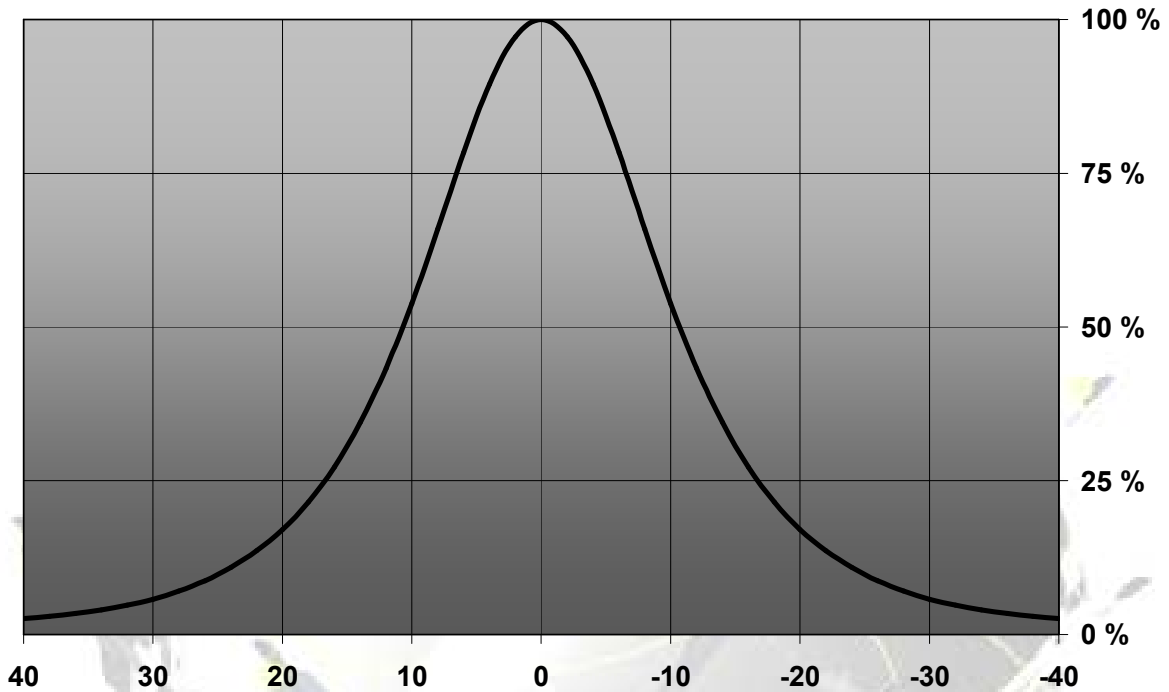

© Ledil Oy – PRELIMINARY - Subject to change without prior notice

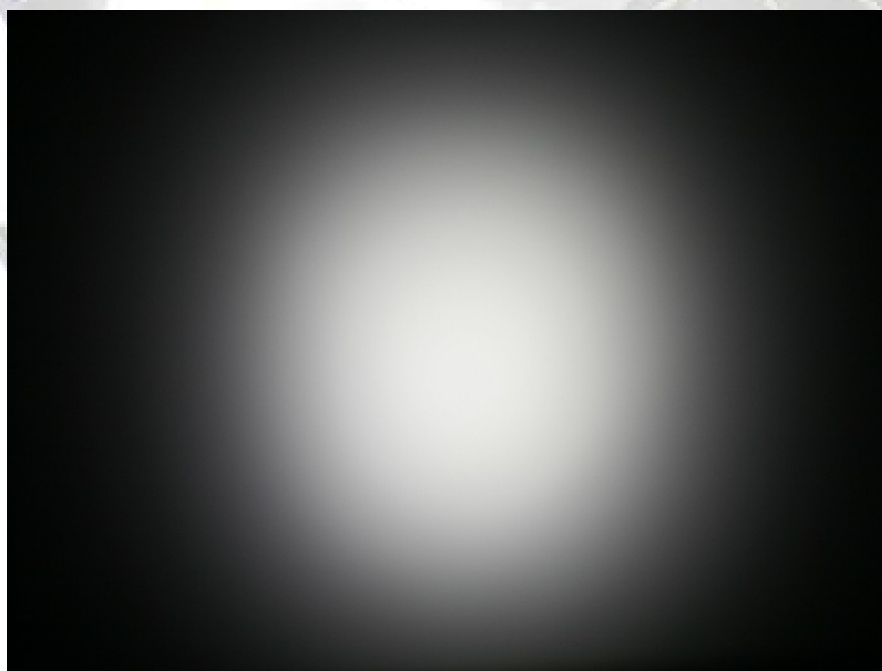
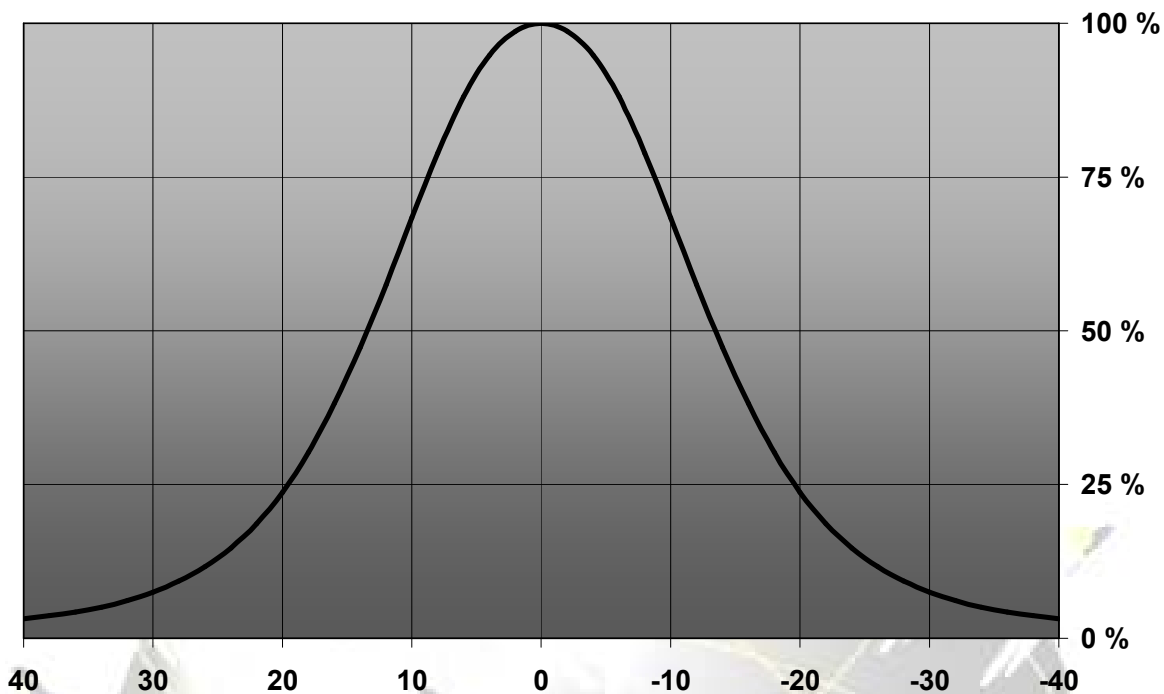
Relative Intensity of C10922_GT4-OSL-M

© Ledil Oy – PRELIMINARY - Subject to change without prior notice

Relative Intensity of C10923_GT4-OSL-W

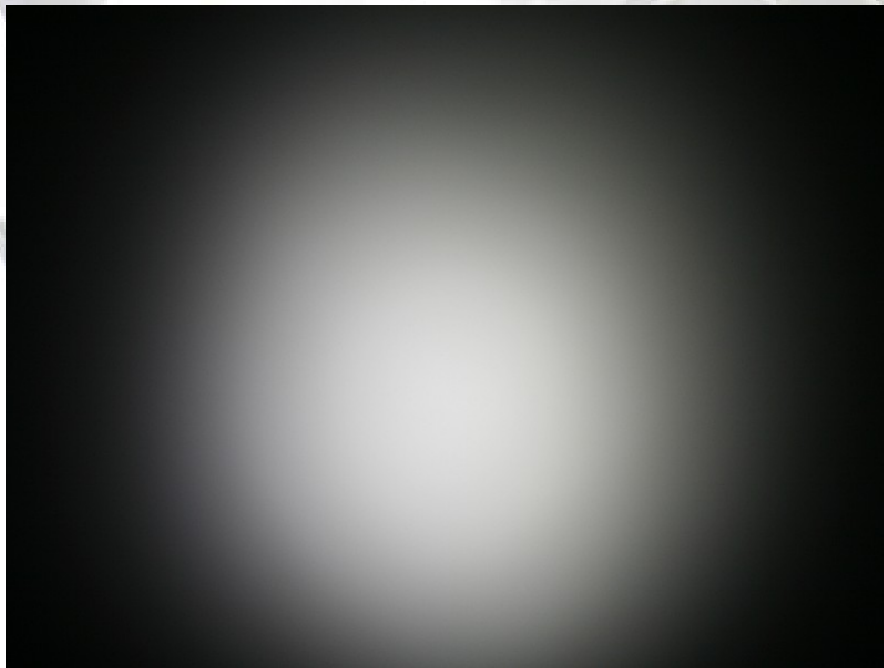
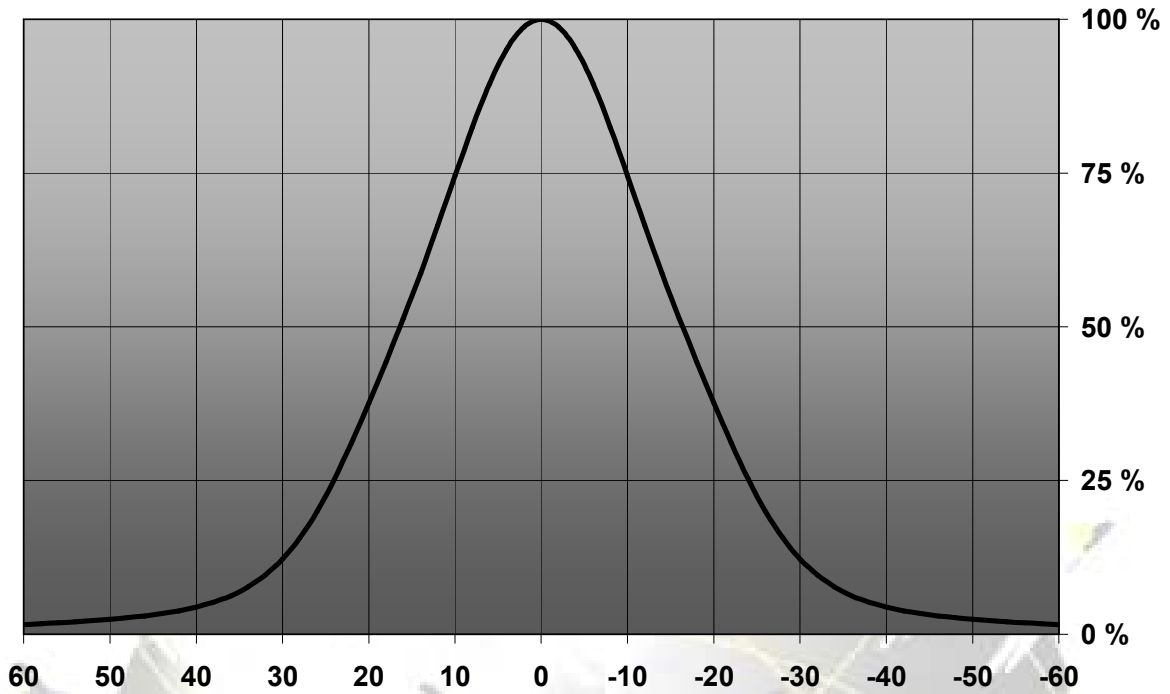

© Ledil Oy – PRELIMINARY - Subject to change without prior notice

Relative Intensity of C10975_GT4-OSL-WW

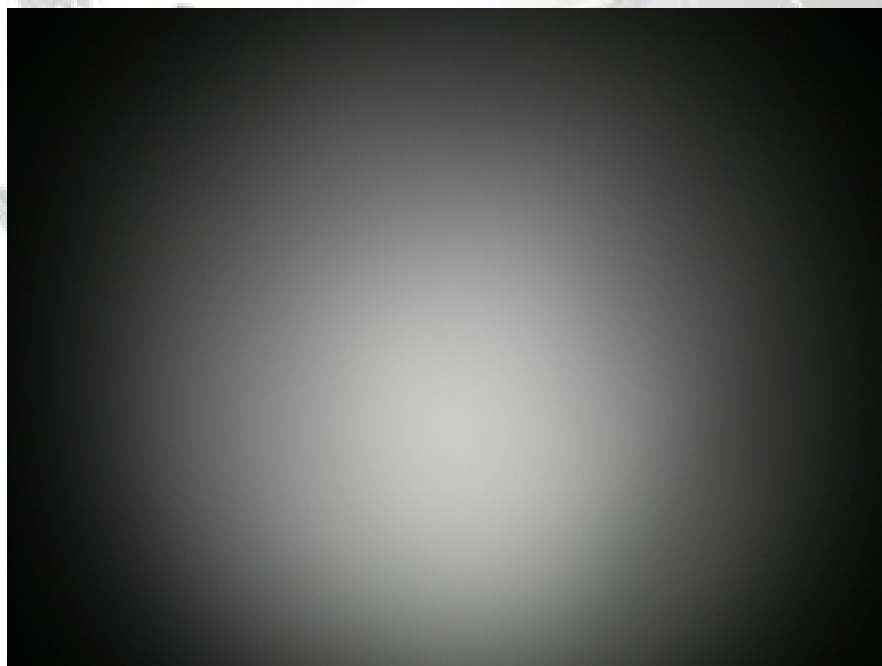
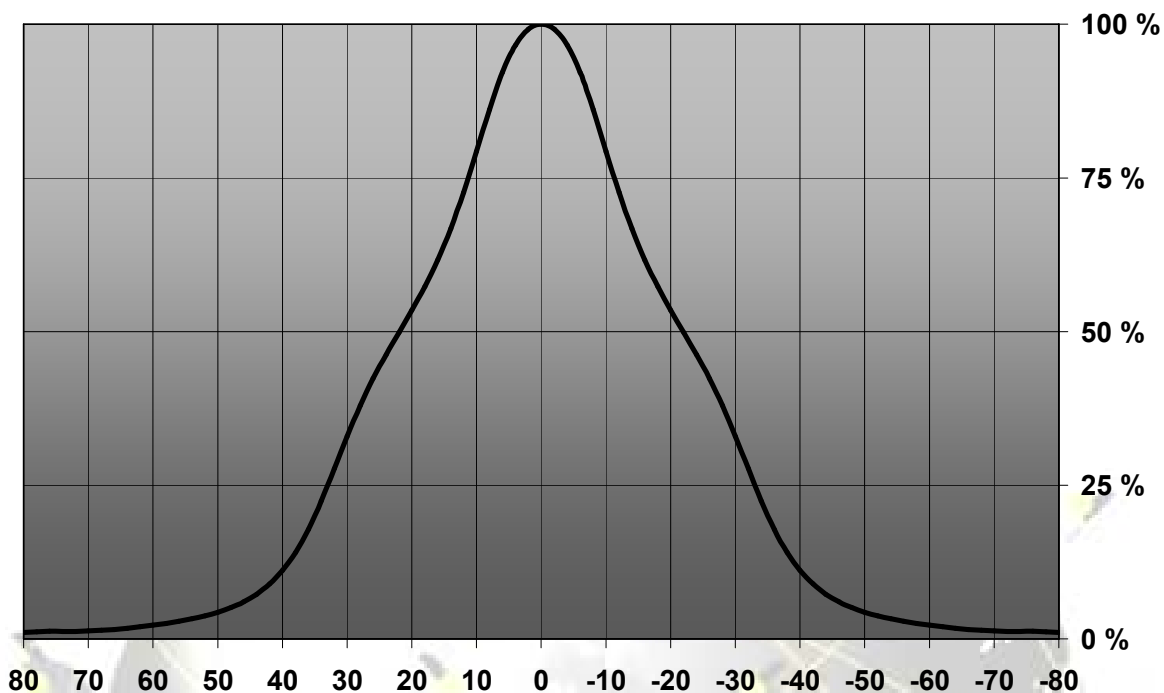

© Ledil Oy – PRELIMINARY - Subject to change without prior notice

DRAWINGS

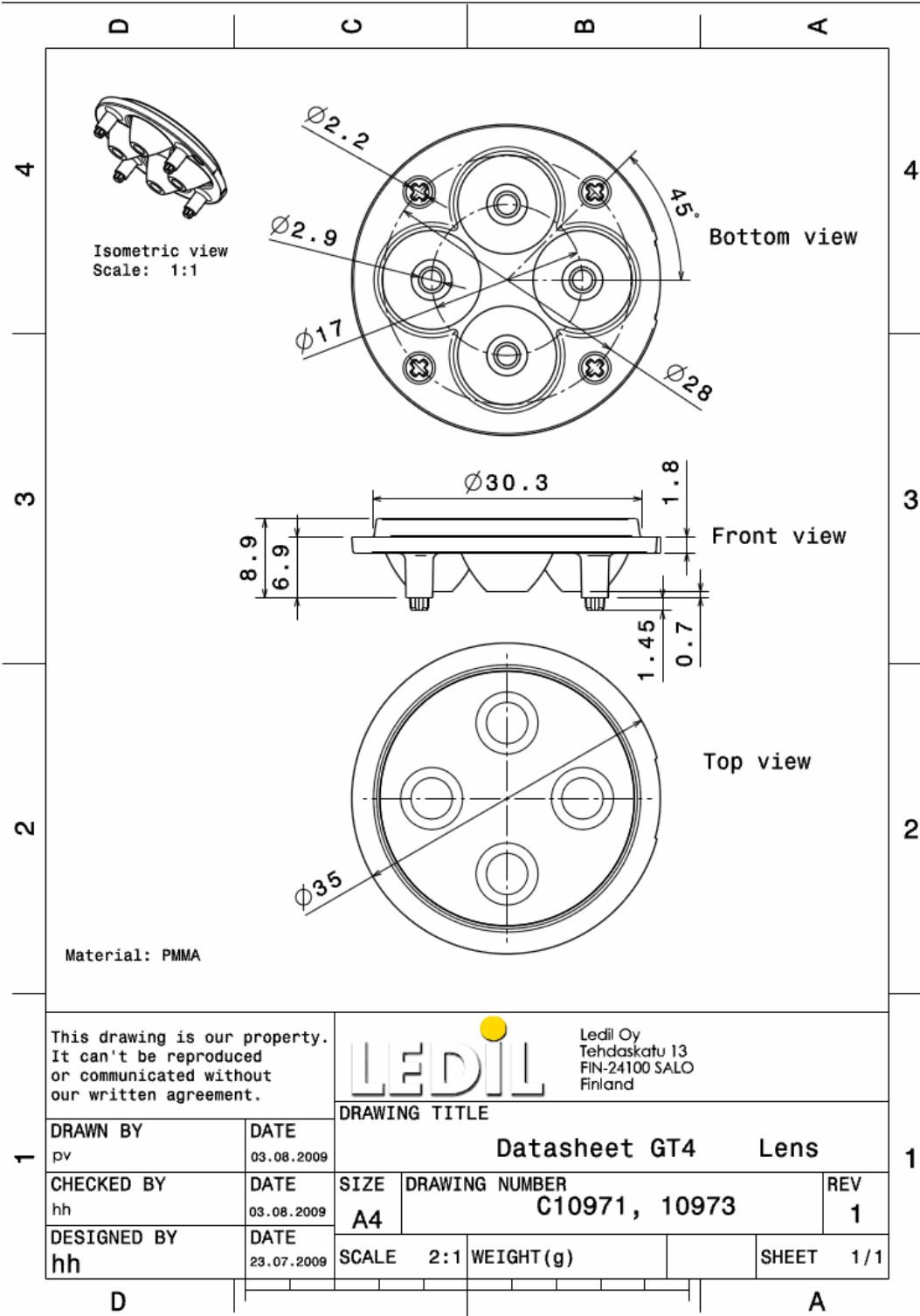

© Ledil Oy – PRELIMINARY - Subject to change without prior notice